

改變生活從浴室開始



2025精選商品型錄

SELECT PRODUCTS CATALOG



金冠 2001

- 一字型 / L型
- 鋁合金 PS板或4mm強化玻璃
- 純白色 · 門檻 777 型

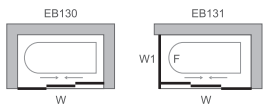
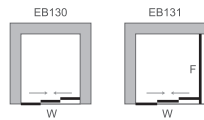

金冠 4000

- 一字型 / L型
- 鋁合金 PS板或4mm或5mm強化玻璃
- 純白/霧銀 · 門檻 777 型

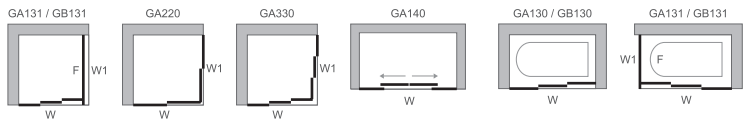
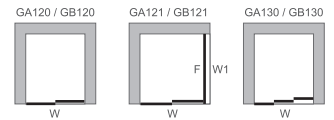

金冠 5000

- 一字型 / L型
- 鋁合金 PS板或4mm強化玻璃
- 純白色 · 門檻 777 型

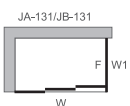
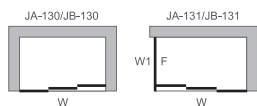

金冠 6000

- 一字型 / L型
- 鋁合金 6mm強化玻璃
- 霧銀色 · 門檻 777 型

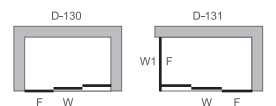



雙向連動門

金冠 6001

- 一字型 無下軌
- 鋁合金 6mm強化玻璃
- 霧銀色 · 門檻 786 型

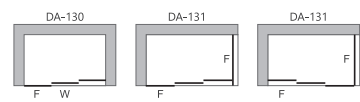

不銹鋼集水槽 (另外選購)



Z-KF004 A型不銹鋼集水槽 Z-KF005 B型不銹鋼集水槽 Z-KF006 C型不銹鋼集水槽

金冠 7000

- 一字型 / L型
- 鋁合金 6mm強化玻璃
- 霧銀色 · 門檻 696 型

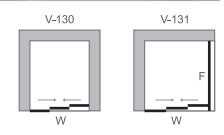

兩移門

皇冠 5028

- 一字型
- 鋁合金 8mm強化玻璃
- 霧銀色 · 門檻 777 型

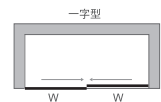

皇冠 5038

- 一字型
- 不銹鋼 10mm強化玻璃
- 白金色 · 門檻 766-1h 型

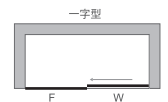

淋浴門-橫拉式 SHOWER ENCLOSURE



皇冠
5048

- 一字型 / L型
- 鋁合金 8mm強化玻璃
- 霧銀色 · 門檻 766-1h 型
- 可選擇把手

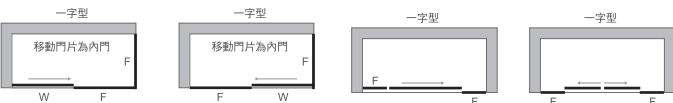
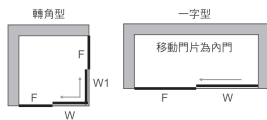

皇冠
5058

- 一字型 / L型
- 不銹鋼 8mm強化玻璃
- 白金色 · 門檻 786h 型
- 可選擇把手

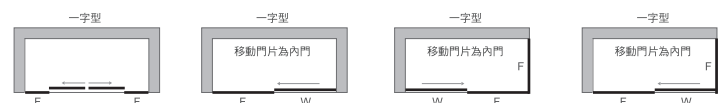
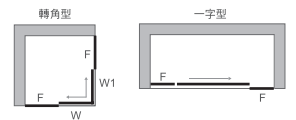

皇冠
5248

- 一字型 / L型
- 不銹鋼或鋁合金 8mm或10mm強化玻璃
- 霧銀色 · 門檻 766-1h 型
- 可分為無緩衝 / 單向緩衝 / 雙向緩衝

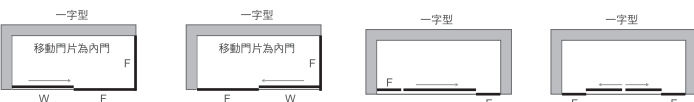
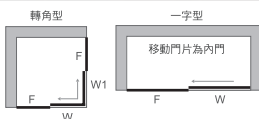

皇冠
5488

- 一字型
- 不銹鋼 8mm強化玻璃
- 白金色 · 門檻 686 型
- 125 ≤ 寬度 ≤ 200cm ; 高度 : 200cm

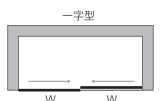

淋浴門-橫拉式 SHOWER ENCLOSURE



金龍 6000

- 圓弧型
- 鋁合金 6mm強化玻璃
- 光鉻色 · 門檻 979 型 55R
- 範圍：90x90cm至116x116cm之間；高度：185cm

SG-03 (55R)

桂冠 3000

- 橫移門
- 鋁合金 5mm壓克力板或5mm強化玻璃貼砂膜
- 純白色

W · 75-90cm H · 90-210cm

淋浴門-外(內)開式 SHOWER ENCLOSURE



皇冠 5024

- 一字型 / L型 / 五角型
- 不銹鋼 8mm強化玻璃
- 白金色 · 門檻 766h 型
- 可選擇把手及固定桿

皇冠 5026

- 一字型 / L型 / 五角型
- 不銹鋼 8mm強化玻璃
- 白金色 · 門檻 766h 型
- 可選擇把手及固定桿



油壓緩衝鉸鏈

- 皇冠 5100**
- 一字型 / L型 / 五角型
 - 不銹鋼 8mm或10mm強化玻璃
 - 白金色 · 門檻 766h 型
 - 可選擇把手及固定桿

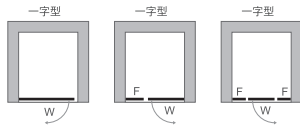

- 皇冠 5198**
- 一字型 / L型
 - 銅鍍鉻+不銹鋼 8mm或10mm強化玻璃
 - 白金色 · 門檻 766h 型

- 70°~75°彈簧回歸，有緩衝
- 可更換為雙向都可以開門

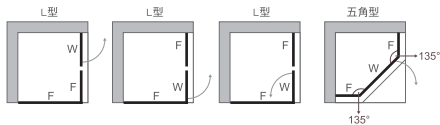
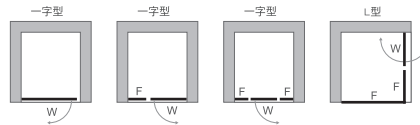

- 皇冠 5300**
- 一字型 / L型 / 五角型
 - 銅鍍鉻 8mm強化玻璃
 - 白金色 · 門檻 766h 型
 - 可選擇把手及固定桿

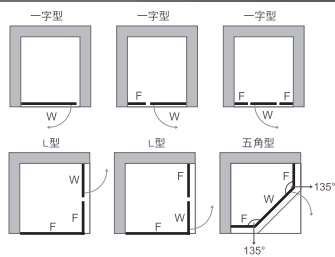

- 皇冠 5700**
- 一字型 / L型 / 五角型
 - 銅鍍鉻 8mm或10mm強化玻璃
 - 白金色 · 門檻 766h 型
 - 可選擇把手及固定桿

- 30°彈簧回歸，無緩衝
- 可更換為雙向都可以開門

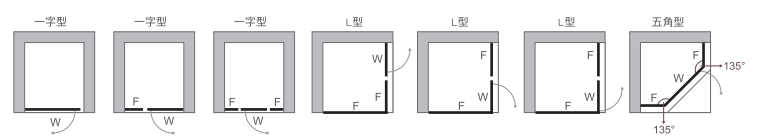

淋浴門-外(內)開式 SHOWER ENCLOSURE



- 皇冠 5800**
- 一字型 / L型 / 五角型
 - 不銹鋼 8mm或10mm強化玻璃
 - 白金色 · 門檻 766h 型
 - 可選擇把手及固定桿
- 45°彈簧回歸，無緩衝

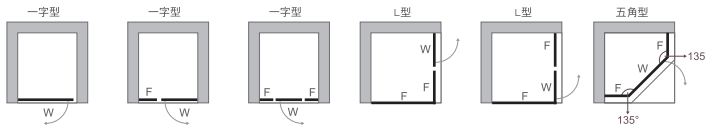

- 皇冠 5900**
- 一字型 / L型 / 五角型
 - 不銹鋼 8mm或10mm強化玻璃
 - 白金色 · 門檻 766h 型
- 可選擇把手及固定桿
 - 平時門須保持關閉狀態
 - 雙向都可以開門(標配)

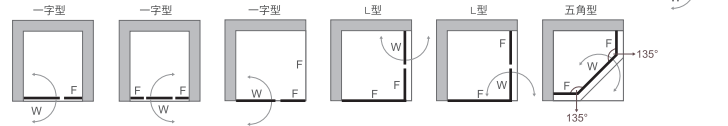

淋浴門-折門式 SHOWER ENCLOSURE



- 皇冠 6800**
- 一字型
 - 銅鍍鉻·不銹鋼·鋁合金滑軌 8mm強化玻璃
 - 霧銀色 · 門檻 766h 型
 - 折門寬度範圍80-100cm

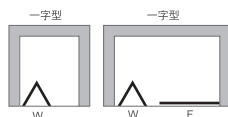

- 海龍 2000**
- 一字型 / L型 / 五角型
 - 鋁合金 PS板或4mm強化玻璃
 - 純白色 · 門檻 777 型

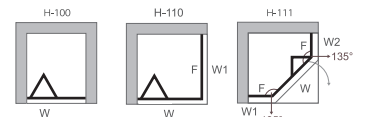

淋浴門-鍍鈦系列 SHOWER ENCLOSURE



- 一字型 / L型 / 五角型
- 不銹鋼鍍鈦 8mm強化玻璃
- 門檻 766h 型
- 可選擇把手

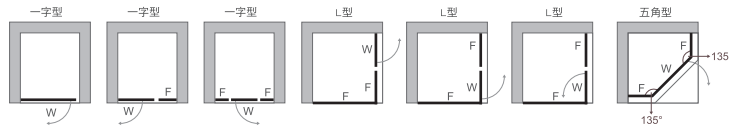

■ 鉸鏈顏色
不銹鋼鏡面拋光鍍鈦鉸鏈
可製作皇冠5024、皇冠5100
兩種型式，以下顏色可選購製作。

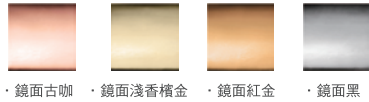

淋浴門-曜石黑系列 SHOWER ENCLOSURE



皇冠5024B / 皇冠5100B / 皇冠5800B

- 一字型 / L型 / 五角型
- 不銹鋼 8mm強化玻璃
- 黑色 · 門檻 766h 型

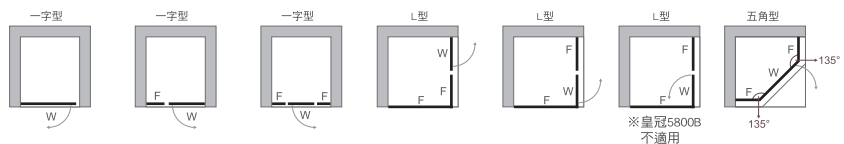

皇冠5248B

- 一字型 / L型
- 鋁合金 8mm強化玻璃
- 黑色 · 門檻 766-1h 型
- 可分為無緩衝 / 單向緩衝 / 雙向緩衝

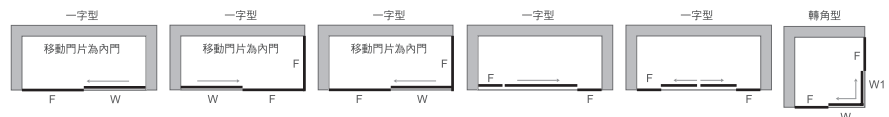

淋浴門-固定桿 SUPPORT BAR



嵌入式固定桿
材質：鋁合金



懸吊式固定桿
材質：不銹鋼 or 銅鍍鉻



減震式固定桿
材質：不銹鋼

淋浴門-門擋 DOOR STOPPER



材質 銅鍍鉻
ET-38



材質 銅鍍鉻
ET-39



材質 不銹鋼
ET-90-11A-SF

淋浴門-玻璃鎖 GLASS LOCK



ET-700C
(推拉門)
玻璃須挖孔



ET-701C
(推拉門)
玻璃須挖孔



ET-600C
(推拉門)
玻璃免挖孔



ET-601C
(推拉門)
玻璃免挖孔



Z-IL700C
(橫拉門)
玻璃須挖孔



Z-IL701C
(橫拉門)
玻璃須挖孔

導水條 WATER GUIDE STRIP

Z-RSA-33L/R

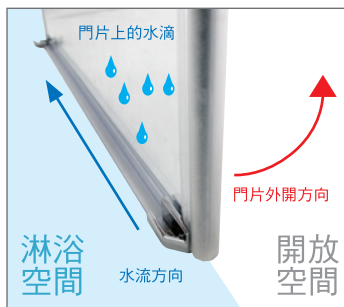

門片開啟，門片上的水滑落至導水條溝槽內。

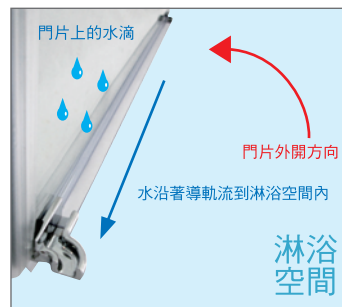

溝槽內的水沿著導水條留置淋浴空間內，不外漏到開放空間。



Z-GH7103



Z-GH7063



ET-18-P-S



ET-18-J



ET-18-P-S-BB



ET-625D-S
(15 cm)



ET-C200-S
(20 cm)



ET-639-S
(52 cm)



ET-628-SS
(45.5 cm)



ET-PB039-S
(45 cm)



ET-624B-S
(45.5 cm)



ET-PH624-S
(45.5 cm)



ET-PH630-S
(45.5 cm)



ET-639-S-BB
(52 cm)



ET-624B-S-BB
(45.5 cm)



ET-PH624-S-BB
(45.5 cm)



ET-PB039-S-BB
(45 cm)



ET-PB6015-BB
(45 cm)

淋浴門-門檻 DOORSILL

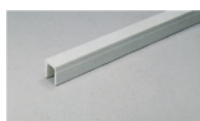

一字型門檻
110 - 200 cm

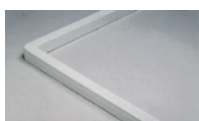

L型門檻
100 x 100 cm
120 x 120 cm



766h



766-1



777



786

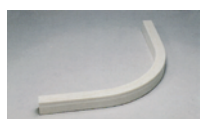

圓弧型門檻
90 x 90 cm
100 x 100 cm
117 x 117 cm

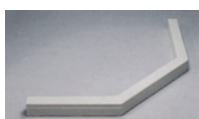

五角型門檻
90 x 90 cm
100 x 100 cm
120 x 120 cm



979



686



696

淋浴門-防水條 WATERPROOF STRIP

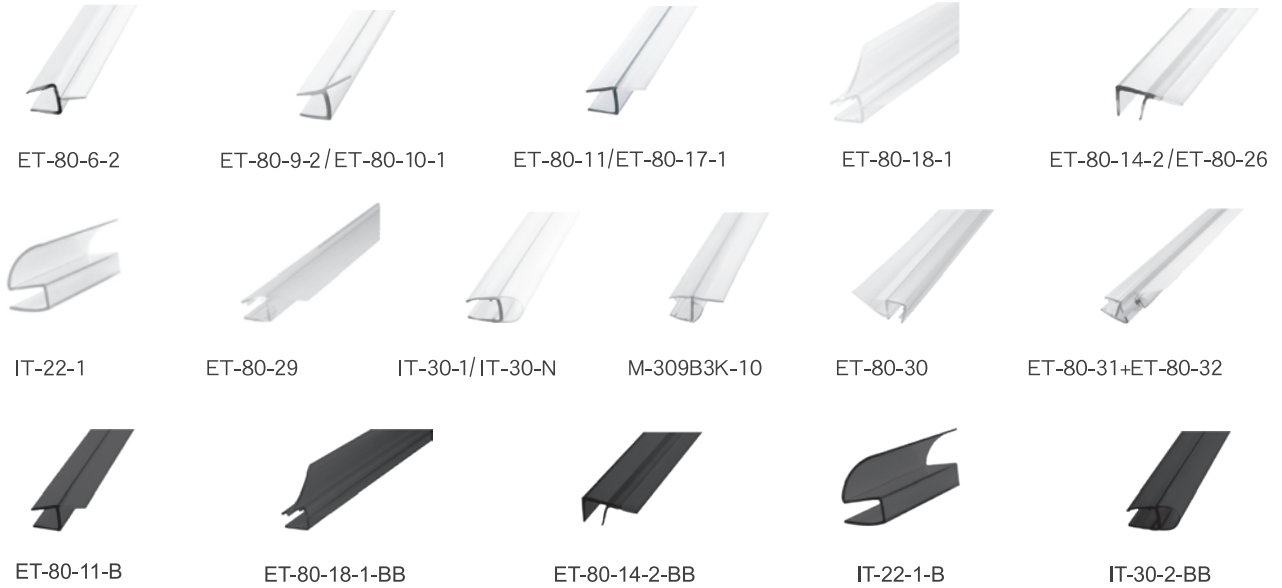

淋浴門-磁鐵條 MAGNETIC STRIP

*圖片僅供參考，實際顏色規格以實品為準



淋浴門-磁鐵支座 MAGNETIC SHOWER SEAL

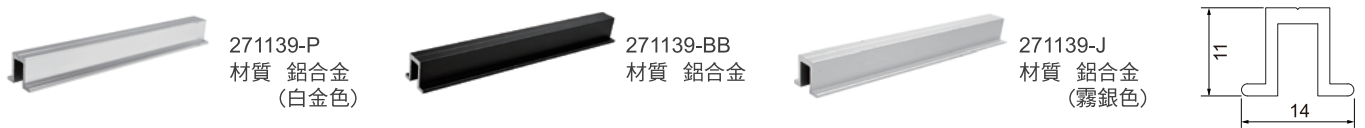

淋浴門-門檻擋水鋁條 ALUMINUM PROFILE



淋浴門-收邊口料 ALUMINUM PROFILE

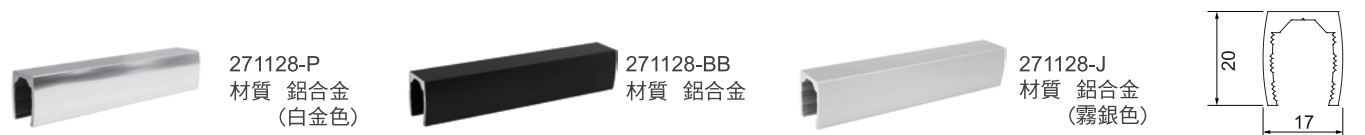

單位: mm

省水馬桶 TOILET



ET-7006A-30/40
 尺寸 70.5 x 40.5 x 69cm
 沖水方式 噴射虹吸式
 排水管距 30cm / 40cm
 洗淨水量 4.8L / 3.0L



ET-7007A-30/40
 尺寸 68.5 x 36.5 x 71.5cm
 沖水方式 龍捲噴射虹吸式
 排水管距 30cm / 40cm
 洗淨水量 4.8L / 3.0L



ET-7008A-40
 尺寸 69.5 x 39 x 70cm
 沖水方式 噴射虹吸式
 排水管距 40cm
 洗淨水量 4.8L / 3.0L
 *此商品無30管距,售完為止



ET-7009A-30/40
 尺寸 70.5 x 40.5 x 67cm
 沖水方式 龍捲噴射虹吸式
 排水管距 30cm / 40cm
 洗淨水量 4.8L / 3.0L

智慧型馬桶 ELECTRONIC TOILET



ET-7010A-30/40
 尺寸 71 x 38.5 x 72cm
 沖水方式 噴射虹吸式
 排水管距 30cm / 40cm
 洗淨水量 4.8L / 3.0L



ET-FDA2105-30/40
 尺寸: 69.1 x 42.6 x 47.6 cm
 沖水方式: 噴射虹吸式
 排水管距: 30.5cm / 40cm
 洗淨水量: 4.8L

微電腦馬桶 ELECTRONIC TOILET SET

全自動洗淨馬桶
A La Uno S160



※遙控器



ET-CH1601WSTW
(自動閉合+洗淨模式)



ET-CH1602WSTW



ET-CH1601WSTW (地板排水)
 ET-CH1602WSTW (地板排水)

尺寸: 38.3 x 70 x 53.8 cm

重量: 約18kg

沖水方式: 漩渦式水流

排水管距: 12 / 20、30.5-51 cm

沖水量: 小3L / 大4.8L

▲特注型號: ET-CH1601PWSTW (牆壁排水)

▲特注型號: ET-CH1602PWSTW (牆壁排水)

※購買前施工須知詳情請洽詢服務人員

全自動洗淨功能馬桶
アラウーノ
A·La·Uno L150



※遙控器



ET-CH150TWSTW (地板排水)

尺寸: 38.3 x 70 x 54 cm

重量: 約20kg

沖水方式: 漩渦式水流

排水管距: 12 / 20、30.5-51 cm

沖水量: 小3L / 大4.8L 使用泡沫防濺功能需0.9L

▲特注型號: ET-CH150TPWSTW (牆壁排水)

※購買前施工須知詳情請洽詢服務人員

itai 微電腦馬桶座 ELECTRONIC TOILET SEAT



ET-FDB878
尺寸：51.5 x 47cm
溫水 / 暖座 / 烘乾
日本京瓷加熱瞬熱供水
醫療級不銹鋼噴頭
獨家紫外線噴頭殺菌
雙重自動脫臭



ET-FDB6110
V型 基本款
尺寸：50.8 x 37.4cm
溫水 / 暖座
瞬熱式快速加熱給水
抑菌噴嘴、座圈
斷電可常溫清洗



ET-FDB6160
V型 遙控款
尺寸：50.8 x 37.4cm
溫水 / 暖座 / 烘乾
瞬熱式快速加熱給水
抑菌噴嘴、座圈
斷電可常溫清洗

微電腦馬桶座 ELECTRONIC TOILET SEAT

itai 免插電馬桶座 NO POWER BIDET SEAT



Panasonic
ET-DL-F509BTWS
尺寸：51.5 x 46.7cm
三段溫控溫水、溫座
不銹鋼噴嘴、噴嘴自淨
抗菌材質、自動節電



HG104D

HG106V

HG104D(左)/HG106V(右)
尺寸：50x36.5 cm / 49.5x36.5 cm
免插電即享免治功能
特殊抗菌材質、便座快適拆卸
便座抗靜電、便座緩降靜音
一鍵操作簡單快捷

浴室空調設備 VENTILATION



Panasonic
ET-FV-40BEN4W
用電：220V
安裝尺寸：40 x 28 x 18cm

LCD無線遙控



Panasonic
ET-FV-40BU1R/W
用電：110V / 220V
安裝尺寸：40 x 28 x 18cm

無線遙控



Panasonic
ET-FV-40BUY1R/W
用電：110V / 220V
安裝尺寸：40 x 28 x 18cm

有線遙控



Panasonic
ET-FV-30BU3R/W
用電：110V / 220V
安裝尺寸：30 x 30 x 18cm

無線遙控



Panasonic
ET-FV-30BUY3R/W
用電：110V / 220V
安裝尺寸：30 x 30 x 18cm

有線遙控



NEW Panasonic
ET-FV-30BD1R/W
用電：110V / 220V
安裝尺寸：30 x 30 x 18cm
● DC馬達

無線遙控

浴室空調設備 VENTILATION



Panasonic

NEW ET-FV-30BDY1R/W
用電：110V / 220V
安裝尺寸：30 x 30 x 18cm
● DC馬達



有線遙控



Panasonic 換氣扇

ET-FV-21CV2R/W
用電：110V / 220V
安裝尺寸：21 x 21 x 19.8cm



nanoeX

●主動分解PM2.5、臭味，有效抑制細菌、黴菌等達99.9%

Panasonic 奈米水離子發生器

ET-FV-15CSD1R
用電：110V
適用管道直徑：Ø15cm
消耗功率：4W

台達 DELTA



NEW 豪華型400系列
遙控：ET-VHB40A(B)DMRT-A
線控：ET-VHB40A(B)DMT-AD
用電：110V / 220V
安裝尺寸：40 x 28 x 20.3cm

台達 DELTA



豪華型300系列
遙控：ET-VHB30A(B)CMRT-A
線控：ET-VHB30A(B)CMT-AD
用電：110V / 220V
安裝尺寸：30 x 30 x 21.3cm



ET-VFB21ABT2-F



ET-VFB21AXT3



ET-VFB21AXT4

- 暖房/涼風/乾燥/換氣
- 感應夜燈/感應換氣
- 六段定時使用方便
- 八重安全防護
- PTC陶瓷加熱器
- 長效濾網設計

台達 DELTA

DC直流節能換氣扇 用電：110V / 220V
安裝尺寸：21x21x16.5 cm

三門鏡櫃 MIRROR



Panasonic
Homes & Living

三門鏡櫃 [洗臉化妝台]
Twin Line LED

Made in JAPAN



*以下為三門鏡櫃的型號，其他商品請另外洽詢

鏡櫃樣式	本體材質	照明(消耗電力)	插座	電源	開關
三門式附LED照明	合成樹脂	LED燈2個(14W)	3個(內2外1) 合計1400W	AC 110V	照明用開關1個
除霧功能	鏡片尺寸 寬mm × 高mm				其他
	750mm	900mm	1000mm	1200mm	
僅中間鏡片有除霧塗層	兩側:164×773 中間:348×773	兩側:235×773 中間:348×773	兩側:235×773 中間:448×773	兩側:335×773 中間:448×773	收納層架: 中間3個,兩側5個
三門鏡櫃型號	ET-GQC75C3SBBETW	ET-GQC90C3SBBETW	ET-GQC10C3SBBETW	ET-GQC12C3SBBETW	

藝術台上瓷盆

VANITY WASH BASIN

*浴櫃及瓷盆尺寸±2cm
*圖片僅供參考,不含龍頭



- EC-J2051 不含龍頭
尺寸: W41 x D41 x H14cm
- P管 K-01M
- 落水頭(銻色)(無溢水孔)
TL-6077



- EC-78352 不含龍頭
尺寸: W42 x D26.5 x H13.5cm
- P管 K-01M
- 落水頭(銻色)(無溢水孔)
TL-6077

檯面下面盆 UNDERCOUNTER WASH BASIN

*浴櫃及瓷盆尺寸±2cm
*圖片僅供參考,不含龍頭



不含龍頭

EC-561
下嵌瓷盆: W55 x D40 x H21cm



不含龍頭

EC-551B
下嵌瓷盆: W38 x D38 x H17.5cm



不含龍頭

EC-540NX
下嵌瓷盆: W51.5 x D38.5 x H18.5cm

時尚浴櫃組 BATHROOM CABINETS

*浴櫃及瓷盆尺寸±2cm
*圖片僅供參考,不含龍頭

- ※ 緩衝設計
EC-8060C-60(盆)/EC-8060C-60B(櫃)
盆: 尺寸 W60 x D50 x H20cm
櫃: 尺寸 W60 x D35 x H60cm

不含龍頭



*此系列商品,售完為止

- ※ 緩衝設計
EC-8075C-75(盆)/EC-8075C-75B(櫃)
盆: 尺寸 W75 x D50 x H20cm
櫃: 尺寸 W75 x D35 x H60cm

- ※ 緩衝設計
EC-8090C-90(盆)/EC-8090C-90B(櫃)
盆: 尺寸 W91 x D50 x H20cm
櫃: 尺寸 W90 x D35 x H60cm

不含龍頭



- ※ 緩衝設計
EC-9335-60(盆)/EC-9335-60B(櫃)
盆: 尺寸 W61 x D47.5 x H25.5cm
櫃: 尺寸 W58.5 x D45.5 x H60cm

- ※ 緩衝設計
EC-9335-70(盆)/EC-9335-70B(櫃)
盆: 尺寸 W71 x D47.5 x H25.5cm
櫃: 尺寸 W68.5 x D45.5 x H60cm

- ※ 緩衝設計
EC-9335-80(盆)/EC-9335-80B(櫃)
盆: 尺寸 W81 x D47.5 x H25.5cm
櫃: 尺寸 W78.5 x D45.5 x H60cm

不含龍頭



※ 緩衝設計
 EC-9050A(盆)/EC-9050A-BW(櫃-雙凹抽)
 盆: 尺寸 W53.5 x D46 x H18.5cm
 櫃: 尺寸 W52 x D45.5 x H60cm

不含龍頭



NEW
 ※ 緩衝設計
 EC-9050A(盆)/EC-9050A-B(櫃)
 盆: 尺寸 W53.5 x D46 x H18.5cm
 櫃: 尺寸 W52 x D45.5 x H60cm

不含龍頭



※ 緩衝設計
 EC-9050A-MB(盆)/EC-9050A-MB-BA(櫃)
 盆: 尺寸 W53.5 x D46 x H18.5cm
 櫃: 尺寸 W52 x D45.5 x H60cm

不含龍頭



※ 緩衝設計
 EC-9048A(盆)/EC-9048A-BA(櫃)
 盆: 尺寸 W48 x D24 x H14.5cm
 櫃: 尺寸 W48 x D23.5 x H50cm

不含龍頭



※ 緩衝設計
 EC-9048AC(盆)/EC-9048AC-BB(櫃)
 盆: 尺寸 W46 x D26 x H12cm
 櫃: 尺寸 W43 x D23 x H53cm

不含龍頭



※ 緩衝設計 · 碳灰鋼烤
 EC-9335-60(盆) / Z-GLDC001(櫃)
 盆: 尺寸 W61 x D47.5 x H25.5cm
 櫃: 尺寸 W58 x D45.5 x H60cm

不含龍頭



※ 緩衝設計 · 陶白鋼烤
 EC-9335-60(盆) / Z-GLDC002(櫃)
 盆: 尺寸 W61 x D47.5 x H25.5cm
 櫃: 尺寸 W58 x D45.5 x H60cm

不含龍頭



※ 緩衝設計 · 原木黃橡
 EC-9335-60(盆) / Z-GLDC003(櫃)
 盆: 尺寸 W61 x D47.5 x H25.5cm
 櫃: 尺寸 W58 x D45.5 x H60cm

不含龍頭



※ 緩衝設計 · 璀璨金鋼烤
 EC-9335-60(盆) / Z-GLDC004(櫃)
 盆: 尺寸 W61 x D47.5 x H25.5cm
 櫃: 尺寸 W58 x D45.5 x H60cm

不含龍頭



※ 緩衝設計 · 北美原橡
 EC-9335-60(盆) / Z-GLDC006(櫃)
 盆: 尺寸 W61 x D47.5 x H25.5cm
 櫃: 尺寸 W58 x D45.5 x H60cm

鏡櫃 MIRROR

*鏡面皆為環保無銅鏡材,延緩氧化速度,減少黑邊產生



※ 緩衝設計 · 碳灰鋼烤
 Z-GLDM001
 尺寸: W60 x D15 x H70cm



※ 緩衝設計 · 陶白鋼烤
 Z-GLDM002
 尺寸: W60 x D15 x H70cm



※ 緩衝設計 · 原木黃橡
 Z-GLDM003
 尺寸: W60 x D15 x H60cm



※ 緩衝設計 · 璀璨金鋼烤
 Z-GLDM007
 尺寸: W60 x D15 x H70cm



※ 緩衝設計 · 北美原橡
 Z-GLDM006
 尺寸: W60 x D15 x H60cm



ET905H
 尺寸：60 x 80 cm



ET907H
 尺寸：60 x 80 cm

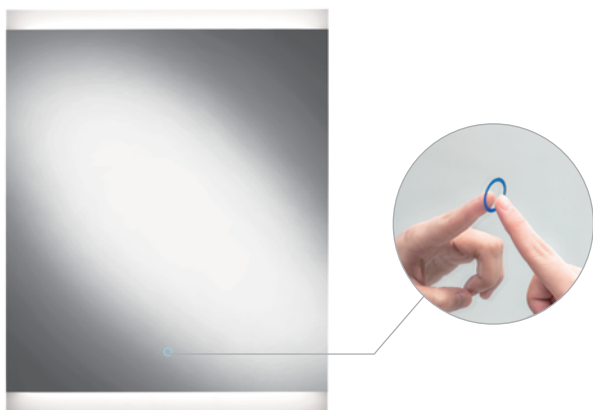

ET051
 尺寸 此為客製化商品

特色：觸控式燈光，需接燈光電源；
 可訂製有除霧或無除霧功能。

※客製尺寸，將由相關人員報價，
 客製化商品無法退貨，請於下訂前
 再次確認規格。



Z-HM-234-B (規格品)
 尺寸 60 x 80 cm

特色：時鐘顯示中下方，揮手感應於
 右下方，LED白光(含除霧功能)。

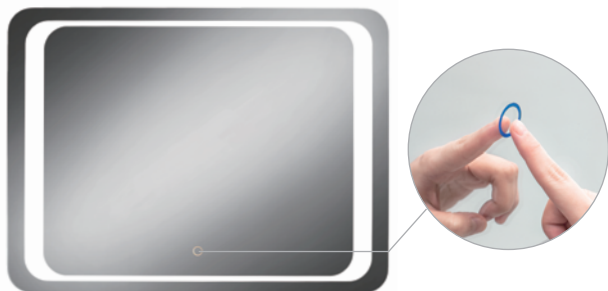

Z-SF005
 尺寸 80 x 60 cm

特色：觸控式燈光，需接燈光電源
 ※可客製尺寸，由相關人員報價，
 客製化商品無法退貨，請於下訂前
 再次確認規格。

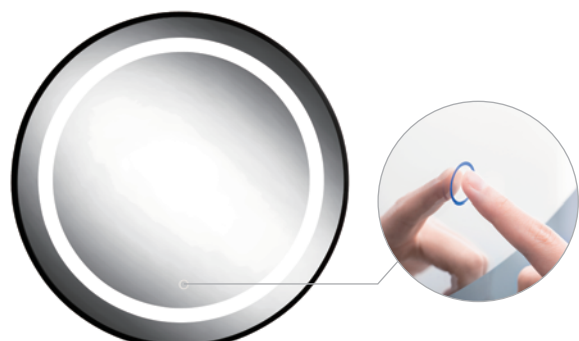

▲ 鋁框

Z-SF006 (規格品)
 尺寸 60 x 60 cm
 70 x 70 cm
 80 x 80 cm

特色：觸控式燈光，需接燈光電源



Z-SF001
 尺寸：50 x 70 cm



Z-SF004
 尺寸：60 x 90 cm



ET-SF101
 尺寸：60 x 80 cm



NEW ET-SF101-B
 尺寸：60 x 80 cm



NEW ET-SF101-W
 尺寸：60 x 80 cm



NEW ET-SF101-DG
 尺寸：60 x 80 cm



Z-SF3001
 尺寸：60 x 80 cm



ET-SF3006
 尺寸：60 x 80 cm



ET-SF3007
 尺寸：60 x 80 cm



ET-SF3008
 尺寸：60 x 80 cm



ET-SF4605
 尺寸：60 x 80 cm



ET-SF4619
 尺寸：60 x 80 cm



ET-SF5157
 尺寸：60 x 80 cm



ET-SF7103
 尺寸：60 x 80 cm



ET-SFA4913
 尺寸：60 x 80 cm



 **LF** 無鉛
Z-TAP-100542
尺寸 H 16cm
材質 銅鍍鉻



Z-TAP-100538
尺寸 H 13.9cm
材質 銅鍍鉻



Z-TD-890
尺寸 H 15cm
材質 銅鍍鉻



 ET-A595
尺寸 H 13cm
材質 銅鍍鉻



 ET-TD-685
尺寸 H 15cm
材質 銅鍍鉻



 Z-D-9088
尺寸 H 15cm
材質 銅鍍鉻



  ET-D-9788
尺寸 H 15cm
材質 銅鍍鉻



 Z-108088
尺寸 H 15.2cm
材質 不銹鋼(毛絲面)



 Z-TAP-500034A
尺寸 H 18cm
材質 不銹鋼(毛絲面)



Z-TD-01MB
尺寸 H 15cm
材質 銅(霧黑)
※ 附霧黑落水頭



  ET-D-9788MB
尺寸 H 15cm
材質 銅(消光黑)
※ 附消光黑落水頭



 Z-108088MB
尺寸 H 15.2cm
材質 不銹鋼(消光黑)
※ 附消光黑落水頭



LF 無鉛
Z-TAP-103536
材質 銅鍍鉻



Z-TAP-103524
材質 銅鍍鉻



Z-SD-890
材質 銅鍍鉻



ET-A590
材質 銅鍍鉻



ET-SD-606
材質 銅鍍鉻



Z-D-9066
材質 銅鍍鉻



恆溫
Z-109366
材質 銅鍍鉻



NEW
ET-D-9765
材質 銅鍍鉻



Z-108066
材質 不銹鋼
(毛絲面)



NEW
Z-TAP-503007A
材質 不銹鋼
(毛絲面)



Z-SD-01MB
材質
主體 銅(霧黑)
蓮蓬頭 不銹鋼(霧黑)



NEW
ET-D-9765MB
材質 銅(消光黑)



Z-108066MB
材質 不銹鋼
(消光黑)



NEW
Z-D-90287
尺寸 H 15.5cm
材質 銅鍍鉻



NEW
Z-W-287
尺寸 H 13.5cm
材質 銅鍍鉻



Z-H-88
材質 銅+塑鋼
特色 自動加壓設計結構
-低水壓適用

滑桿 SLIDE SHOWER



Z-D-115
尺寸：H 69 cm
材質：不銹鋼、ABS電鍍固定座



Z-D-118
尺寸：H 65.8 cm
材質：不銹鋼、ABS電鍍固定座



Z-TAP-518212
尺寸：H 66 cm
材質：不銹鋼(毛絲面)



Z-D-212
尺寸：H 65.8 cm
材質：不銹鋼(消光黑)

沖洗器 FLUSHER



Z-WP-900
材質 不銹鋼(毛絲面)



Z-WP-1100
材質 銅鍍鉻



Z-WP-1400
材質 不銹鋼(毛絲面)



Z-TAP-535008
材質 不銹鋼(消光黑)

花灑 SHOWER SET

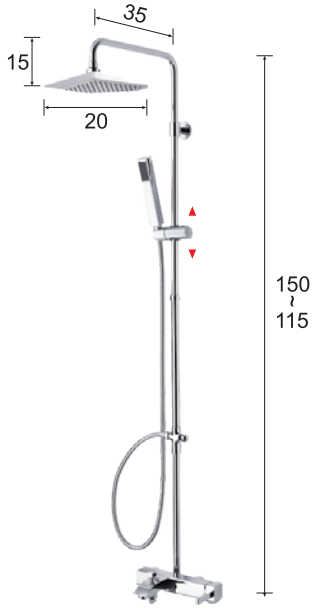

Z-SL-2000-24
尺寸：H 115-150 cm
材質：銅鍍鉻

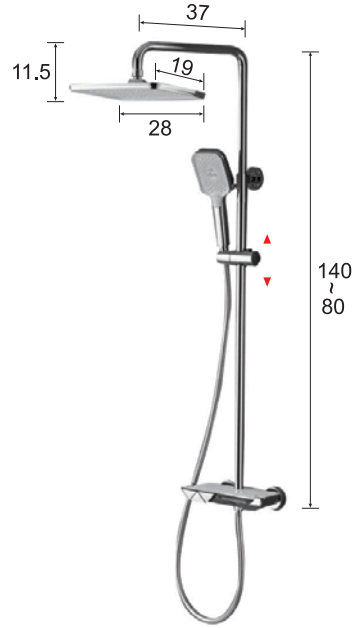

恆溫
ET-SL-333
尺寸：H 80-140 cm
材質：銅鍍鉻

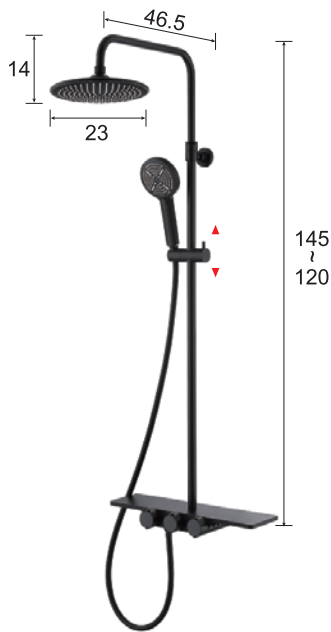

恆溫
Z-109598
尺寸：H 120-145 cm
材質：銅+ABS外殼(消光黑)
備註：冷熱水間距15.2±1.5cm
冷熱出水口需同一水平

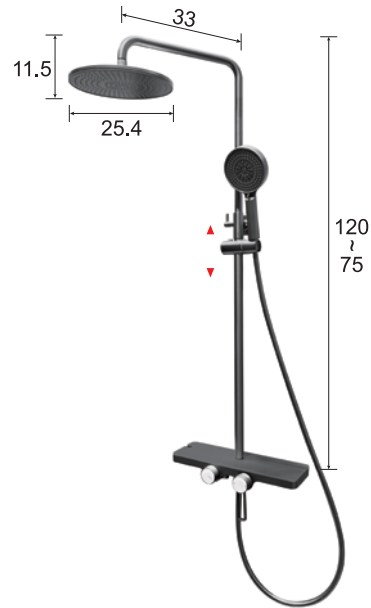

NEW
ET-BF65496BGS
尺寸：H 75-120 cm
材質：PPA+ABS
備註：冷熱水間距15±1cm
冷熱出水口需同一水平

浴缸龍頭 FAUCETS



Z-SB-0403
管徑：1/2"
材質：出水瀑布(不銹鋼)
開關把手(銅鍍鉻)
※ 附冷熱水貼紙



Z-SB-0405
管徑：1/2"
材質：出水瀑布(不銹鋼)
開關把手(銅鍍鉻)
※ 附冷熱水貼紙



AF120
尺寸：118 x 70 x 56 cm



ET-803
尺寸：121 x 75 x 70 cm



Z-A147 尺寸：140 cm
Z-A157 尺寸：150 cm
Z-A177 尺寸：169 cm



走入式浴缸

ET-AD-D0001-R/L
尺寸 132 x 75 x 104 cm
材質 壓克力+ FRP

ET-AD-D0002-R/L
尺寸 110 x 68 x 102 cm
材質 壓克力+ FRP

※圖示為ET-AD-D0001-L左開型式

蒸氣機 STEAM GENERATOR



蒸氣機尺寸：W45 x D15 x H33 cm
功率：6kw / 8kw
電壓：220V

蒸氣機尺寸：W45 x D15 x H37 cm
功率：10kw
電壓：220V



控制面板



多功能蒸氣盒

ET-S78-6 手動排水 (6kw)	ET-S78-6A 自動排水 (6kw)
ET-S78-8 手動排水 (8kw)	ET-S78-8A 自動排水 (8kw)
ET-S78-10 手動排水 (10kw)	ET-S78-10A 自動排水 (10kw)



Z-D-11001
尺寸 60 cm
材質 不銹鋼



Z-D-15001
尺寸 60 cm
材質 不銹鋼



Z-D-11008
尺寸 60 cm
材質 不銹鋼



Z-D-15008
尺寸 60 cm
材質 不銹鋼

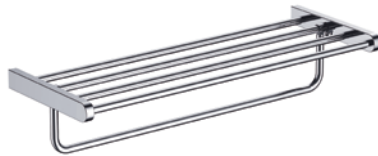

Z-D-11010
尺寸 60 cm
材質 不銹鋼



Z-D-15010
尺寸 60 cm
材質 不銹鋼



Z-P-41MB
尺寸 60 cm
材質 銅(霧黑)



Z-22001MB
尺寸 63 cm
材質 不銹鋼(消光黑)



Z-22008MB
尺寸 63 cm
材質 不銹鋼(消光黑)



Z-P-412MB
尺寸 60 cm
材質 銅(霧黑)



Z-22010MB
尺寸 63 cm
材質 不銹鋼(消光黑)



玻璃固定面毛巾架
Z-PB6015-6
尺寸 60 cm
材質 不銹鋼



玻璃固定面毛巾架
ET-640-S
尺寸 45.5 cm
材質 不銹鋼



Z-D-11006
材質 不銹鋼



Z-D-15006
材質 不銹鋼



Z-D-11005
材質 不銹鋼



Z-D-15005
材質 不銹鋼

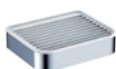

Z-D-11004
尺寸 11.1x9.2x2.5 cm
材質 不銹鋼



Z-D-11015
尺寸 32.1x10.7x2.5 cm
材質 不銹鋼



Z-D-15004
尺寸 11x12.7x4 cm
材質 不銹鋼



Z-D-11009
材質 不銹鋼



Z-D-15009
材質 不銹鋼



Z-D-11003
材質 不銹鋼



Z-D-15003
材質 不銹鋼



Z-D-12751
尺寸 24.5x13x4 cm
材質 ABS、不銹鋼
※不含擺飾品



Z-D-12752
尺寸 24.5x13x4.2 cm
材質 ABS、不銹鋼
※不含擺飾品



Z-D-415
尺寸 28x10x8.5 cm
材質 銅鍍鉻
※不含擺飾品



Z-D-416
尺寸 16.5x10x8.5 cm
材質 銅鍍鉻



Z-D-11002
材質 不銹鋼



Z-D-135
尺寸 45x12x60 cm
材質 ABS、不銹鋼桿、
鋁合金烤漆平台
※不含擺飾品

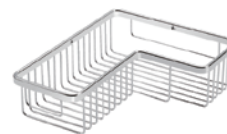

Z-D-2627
尺寸 29.5x24x8 cm
材質 銅鍍鉻



Z-D-410
尺寸 20.5x5.6 cm
材質 ABS、不銹鋼
※不含擺飾品



Z-D-411
尺寸 29x12.3x5.6 cm
材質 ABS、不銹鋼
※不含擺飾品



Z-D-412
尺寸 29x20.7x68 cm
材質 ABS、不銹鋼



Z-22006MB
材質 不銹鋼(消光黑)



Z-22005MB
材質 不銹鋼(消光黑)



Z-22004MB
尺寸 12.5x12.7x5 cm
材質 不銹鋼(消光黑)



Z-22009MB
材質 不銹鋼(消光黑)



Z-22003MB
材質 不銹鋼(消光黑)



Z-22002MB
材質 不銹鋼(消光黑)



Z-D-468
尺寸 20.5x5.6 cm
材質 不銹鋼(消光黑)



Z-D-467
尺寸 29x12.3x5.6 cm
材質 不銹鋼(消光黑)



一字型安全扶手

ET-GB100-50

尺寸 50 cm

材質 ABS 含鋁管塑膠抗菌扶手
+不銹鋼固定座

最大承重 120 kg

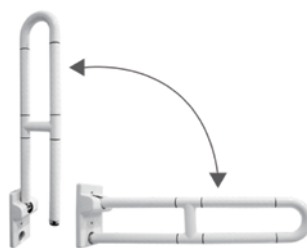

收納式安全扶手

ET-SB100-70

尺寸 70 cm

材質 ABS 含鋁管及不銹鋼管
塑膠抗菌扶手、不銹鋼固定座

最大承重 120 kg



L型安全扶手

ET-GB400-40X60

尺寸 40 x 60 cm

材質 ABS 含鋁管塑膠抗菌扶手
+不銹鋼固定座

最大承重 120 kg



V型安全扶手

ET-GB500-40X60

尺寸 40 x 60 cm

材質 ABS 含鋁管塑膠抗菌扶手
+不銹鋼固定座

最大承重 120 kg



上翻安全扶手

ET-8925-75

尺寸 75 x 11 x 18 cm

材質 不銹鋼+PP+鋁合金固定座

最大承重 115 kg



上翻安全扶手-豪華版

ET-8917G-75

尺寸 75 x 10 x 20.9 cm

材質 鋁合金+PP

最大承重 93 kg

ET-AD-A0001



ET-AD-A0001+ET-AD-A0001L



百變扶手

ET-AD-A0001 (標準段)

ET-AD-A0001L(加長段)

尺寸 35 x 10.4 cm

材質 PP

最大承重 100 kg



鋁合金活動扶手

ET-AD-A0002

尺寸 65.7 x 42.4 cm

材質 鋁合金

最大承重 93 kg



可調節淋浴椅(含椅背)

ET-AD-B0001

尺寸 32 x 36 x 67.4 cm

材質 鋁合金支架+UF板

最大承重 112 kg



上翻淋浴椅

ET-8889
尺寸 38 x 31.5 x 55.1 cm
材質 ABS+不銹鋼
最大承重 300 kg



折疊淋浴椅

ET-SB007Q
尺寸 58.1 x 54.5 x 86.7 cm
材質 ABS+鋁製烤漆
最大承重 285 kg



NEW 淋浴椅

ET-AD-B0003
尺寸 56 x 43.7 H68.2-78.2 cm
材質 鋁合金+PP+TPE
最大承重 120 kg



NEW 便盆淋浴兩用椅

ET-AD-B0004
尺寸 55 x 50.2 H:74.3-82.5cm
材質 鋁合金+PP+PU



馬桶安全扶手

ET-AD-A0003W
尺寸 W: 64 cm H: 57-72 cm
材質 不銹鋼噴漆+PP
最大承重 150 kg



馬桶輔助升降椅

ET-AD-B0002
尺寸 60.8 x 52.5 x 70.5 cm
材質 不銹鋼+ABS
最大承重 150 kg(座椅)



電動升降洗手台

ET-AD-C0001
尺寸 W: 77 cm H: 82-112 cm
材質 不銹鋼面板+人造石面盆



養護浴座

ET-CB0506
尺寸 65.3 x 77.9 x 130 cm
材質 淋浴臂304不銹鋼、椅背PS、座椅
ABS+HDPE、扶手ABS+304不銹鋼、
花灑ABS
最大承重 110 kg (座椅)



Panasonic
孝順長輩 溫心上市

健康浴座

ET-GK6GVL9411YL (有椅子)
ET-GK6GVL9413YL (無椅子)
尺寸 82.2 x 119 x 73 cm
日本原裝進口 (蓮蓬頭在左)

遠紅外線健康屋 INFRARED SAUNA CABINS



循環、代謝、活化
健康養生好氣色



· 內部觸控電子面板



· 高級喇叭

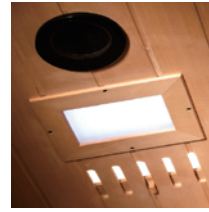

· LED 多段情境燈
· 透氣孔天窗



· 感溫探頭，安全恆溫



· 空氣對流口



· 高精度鉸鏈

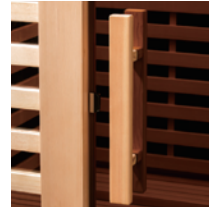

· 安靜易開合磁吸式玻璃門



· 內部環繞碳纖維板，加熱快速



FIR-6106A
規格：單人座
尺寸：81 x 88 x 188cm
材質：鐵杉木
用電：110V
耗電量：1150W



FIR-6103C
規格：單人座
尺寸：98 x 98.5 x 195cm
材質：鐵杉木
用電：220V
耗電量：1525W



FIR-6203C
規格：雙人座
尺寸：120 x 100 x 195cm
材質：鐵杉木
用電：220V
耗電量：1800 W

旋轉鞋架 SHOE RACK

【安裝注意事項】：為提供櫃體穩固安全性，需留意底板，下部不得懸空，如懸空櫃須補強層板。



6層旋轉鞋架
ET-CAS-06
安裝淨尺寸：77x38x91.8cm
產品淨尺寸：72x35x91.8cm
毛重：15kg
存鞋量：24雙



8層旋轉鞋架
ET-CAS-08
安裝淨尺寸：77x38x118cm
產品淨尺寸：72x35x118cm
毛重：19kg
存鞋量：32雙



10層旋轉鞋架
ET-CAS-10
安裝淨尺寸：77x38x143.7cm
產品淨尺寸：72x35x143.7cm
毛重：22kg
存鞋量：40雙



12層旋轉鞋架
ET-CAS-12
安裝淨尺寸：77x38x168.5cm
產品淨尺寸：72x35x168.5cm
毛重：25kg
存鞋量：48雙



NEW

遠紅外線足浴桶
FIR-188
消耗功率：170W
尺寸：45x35x40.5cm
重量：約6.5kg



3D足部按摩器(金)
IT2698
消耗功率：48W
尺寸：42x45x32cm
重量：6.5kg



行動按摩椅墊
ET-260
消耗功率：48W
尺寸：42x45x82cm
重量：7.5kg



折疊椅
ET-MD-00053
尺寸：71x58x108cm

cooksclub



水果冰淇淋機
ET-FDM-1301
尺寸：30x17x20cm
重量：1.45kg

cooksclub



水果冰淇淋機
ET-FDM-1301
尺寸：30x17x20cm
重量：1.45kg

家用清潔系列 CLEANING SUPPLIES



無線多功能清潔機
ET-CDB800
尺寸：21x21x105cm
重量：1.3kg
電源規格：100V-240V



NEW

英國多功能旋轉刷
ET-HS265
尺寸：21x11.5x10cm
重量：319g
電源規格：5V



NEW

一太水垢清
ET-W0001
用途：水龍頭/磁磚/洗手台/
鏡面/馬桶等清潔除垢
容量：400ml±5%



NEW

一太油垢清
ET-G0001
用途：排油煙機/瓦斯爐/
流理台等清潔除垢
容量：400ml±5%

毅太企業股份有限公司
— 太衛浴設備股份有限公司

E TAI Enterprise Co., Ltd. <http://www.itai.com.tw>

台北分公司

台北市中山區建國北路二段147號6樓
 TEL:02-2505-0606

建國旗艦店

台北市中山區建國北路二段141號
 TEL:02-2515-9199

桃園分公司

桃園市桃園區經國路9號4樓之1
 TEL:03-316-2333

新竹分公司

新竹縣竹北市光明十一路9號
 TEL:03-553-9111

台中分公司

台中市北區青島路二段20號
 TEL:04-2292-1999

嘉義分公司

嘉義市西區高鐵大道141號
 TEL:05-235-3111



基隆總公司/觀光工廠

基隆市安樂區武訓街51號(大武崙工業區)
 TEL:02-2434-2111
 觀光工廠團體預約專線: 0934-222-961
 觀光工廠團體預約專線: 02-2430-2846

宜蘭分公司

宜蘭縣宜蘭市女中路二段348號
 TEL:03-936-1336

台南分公司(台南廠)

台南市南區新義南路10號
 TEL:06-265-0111

高雄分公司

高雄市鼓山區九如四路1550號
 TEL:07-581-2888

屏東分公司

屏東縣屏東市和平路485號
 TEL:08-733-7111

客戶服務專線
 0800-042-111

- 本公司產品種類眾多，僅此節錄部分商品，如需詳細資料，請洽各營業處所。
- 本型錄為毅太企業股份有限公司版權所有，所有圖文嚴禁翻印、拷貝、轉印、局部取用，違者必究。
- 本型錄產品規格、顏色如有偏差，以現場實際產品規格、顏色為準。
- 本型錄產品之牌價均未含安裝費，詳細價格請洽各營業所。
- 商品成本售價逐年增減變動，實際售價以最新版本型錄為準。



輔具型錄



官方網站



Facebook